

- > Ø 10 ... 40 mm
- > High quality sliding bearings ensure long durable life and high guidance performance
- > Double piston rod provides high bending and torsional rigidity
- > Magnetic piston as standard

- > Easy to install-reduces costly design time

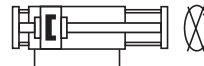

### Technical features

#### Medium:

Compressed air, filtered, lubricated or non-lubricated

#### Operation:

Double acting with magnetic piston and buffer cushioning

#### Operating pressure:

1 ... 8 bar (14 ... 116 psi)

#### Port size:

M5, G1/8

#### Cylinder diameters:

10, 16, 25, 32, 40mm

#### Maximum load:

See details overleaf

#### Standard strokes:

See below

#### Non-standard strokes:

On request

#### Operating temperature:

+80°C max. (+176°F)

Air supply must be dry enough to avoid ice formation at temperatures below +2°C (+35°F).

#### Materials:

Piston: hard chromed steel piston,  
Body and end covers: anodised aluminium  
Seals: NBR

### Technical data

Cylinder Ø (mm)	10	16	25	32	40
Port size	M5	M5	M5	G1/8	G1/8
Piston rod Ø (mm)	6	10	16	20	25
Theoretical thrusts at 6 bar (N)	60	147	348	588	918
Air consumption at 6 bar (l/cm)	0,04	0,172	0,406	0,686	1,072

### Standard strokes

Cylinder Ø (mm)	Strokes (mm)								
	25	50	75	100	125	150	175	200	225
10	•	•	•	•	—	—	—	—	—
16	•	•	•	•	•	•	—	—	—
25	—	•	•	•	•	•	•	•	—
32	—	—	•	•	•	•	•	•	—
40	—	—	—	—	•	•	•	•	•

### Weight

Cylinder Ø (mm)	Strokes (mm)								
	25	50	75	100	125	150	175	200	225
10	0,39	0,40	0,41	0,42	—	—	—	—	—
16	0,77	0,80	1,08	1,11	1,39	1,42	—	—	—
25	—	1,96	2,00	2,46	2,50	2,96	3,00	—	—
32	—	—	3,74	3,80	4,51	4,57	5,28	5,34	—
40	—	—	—	6,70	6,80	7,84	7,93	8,97	9,10

### Option selector

Cylinder Ø (mm)	Substitute
10	11
16	16
25	25
32	32
40	40

M/601★★/M/★★★

Strokes (mm)
max. 225

**Permissible cushion loads**

Application: slide mounting

Application: end mounting

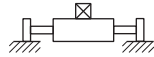
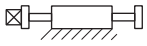

**M/60111/M**

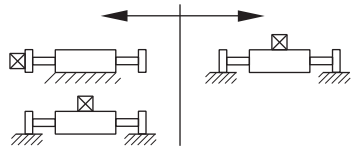
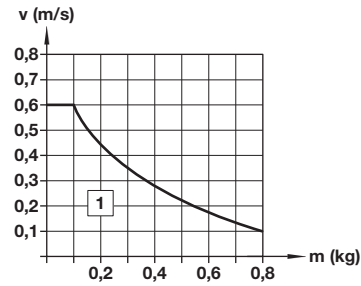

**M/60116/M**

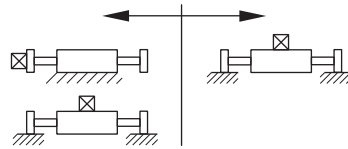
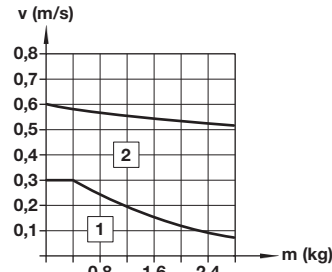

**M/60125/M**

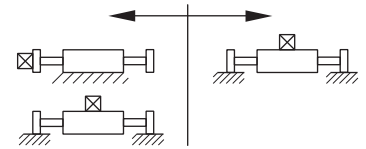
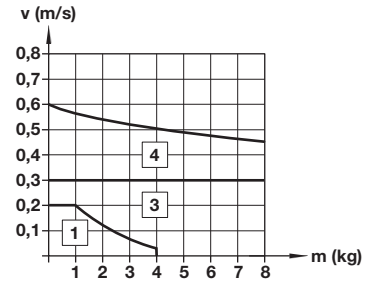

**M/60132/M**

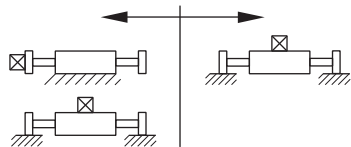
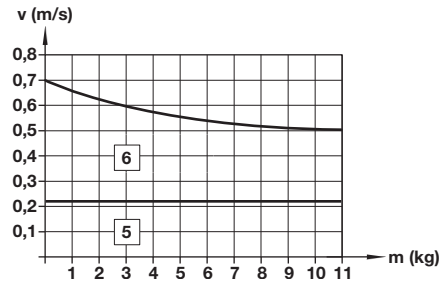

**M/60140/M**

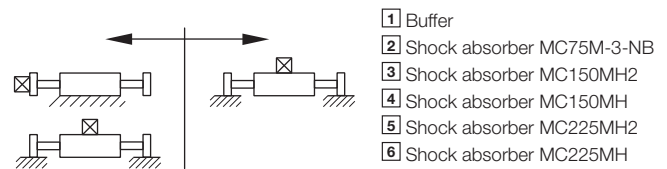
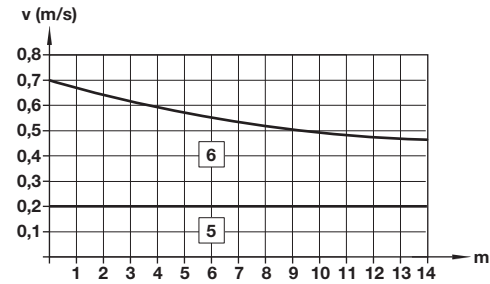

- 1 Buffer
- 2 Shock absorber MC75M-3-NB
- 3 Shock absorber MC150MH2
- 4 Shock absorber MC150MH
- 5 Shock absorber MC225MH2
- 6 Shock absorber MC225MH

**Max. load  
(with constant bearing load)**

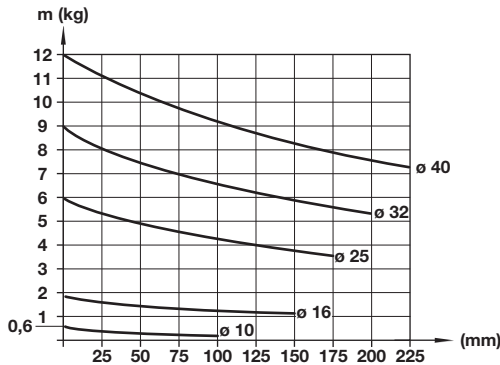

**Deflection  
(with maximum load)**

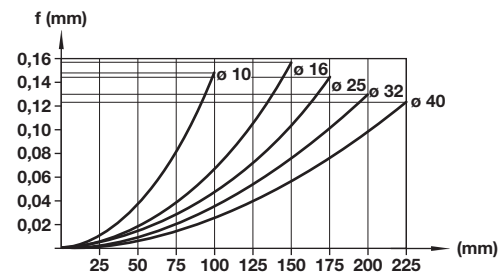

**Drawing  
M/60111/M**

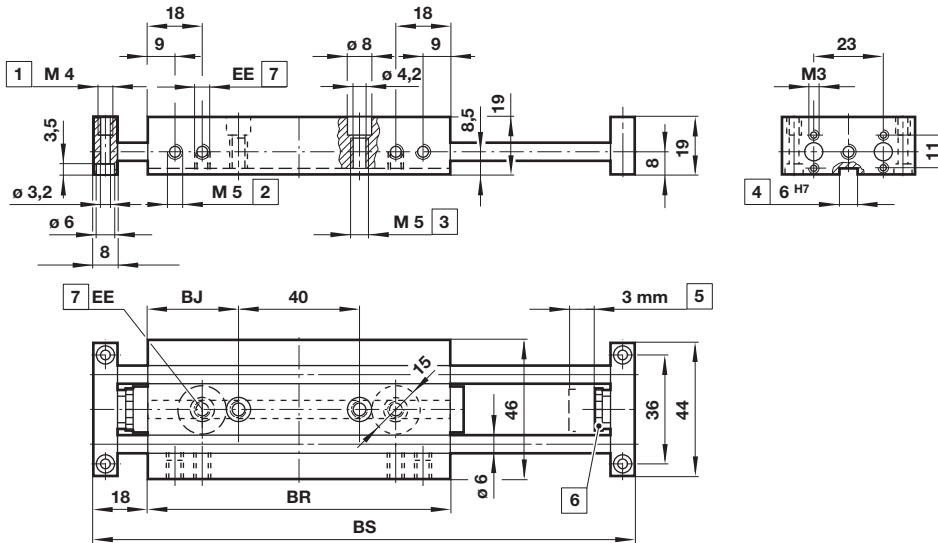
 Dimensions in mm  
Projection/First angle

- 1 6 deep
- 2 5,5 deep
- 3 10 deep
- 4 2 deep
- 5 3 mm control range both ends
- 6 Stop screw
- 7 Port size (EE = M5)

Stroke	25	50	75	100
BJ	30	30	55	55
BR	100	100	150	150
BS	161	186	261	286

**Intermediate stroke length screw**

Slide unit	Control range (mm)				
	5	10	15	20	25
M/60111/M	M/P70870/1	M/P70870/2	M/P70870/3	M/P70870/4	M/P70870/5

**Drawing**  
M/60116/M ... M/60140/M

Dimensions in mm  
Projection/First angle

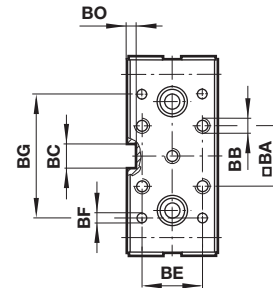
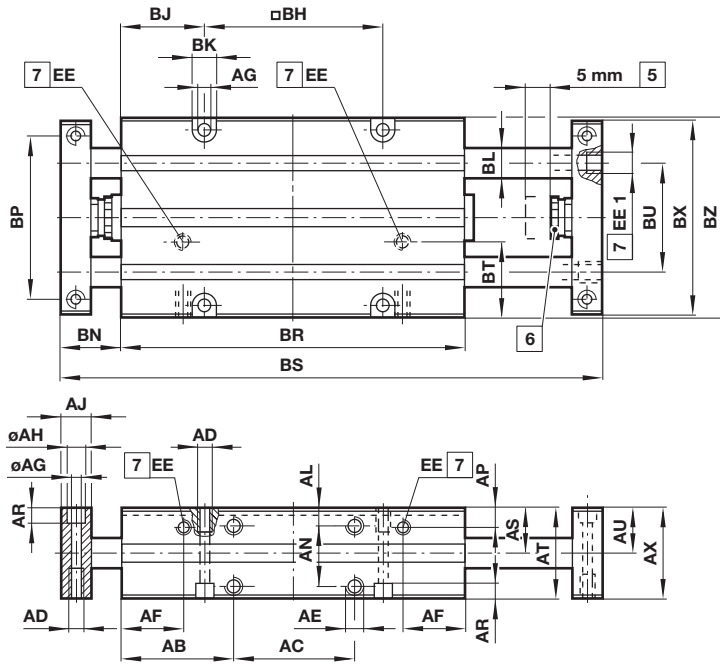

- 5 5 mm control range both ends
- 6 Stop screw
- 7 Port size

AB	AC	AD	AE	AF	Ø AG	Ø AH	AJ	AL	AN	AP	AR	AS	AT	AU	AX	BA	BB	Model
37	40	M5 x 8 deep	M5 x 7 deep	20,5	4,2	8	10	6	20	6,5	5	16	30	15	30	20	M5	M/60116/M
46	60	M6 x 12 deep	M6 x 8 deep	22,5	5,3	10	12	9,5	24	7,5	6	21,5	40	20,5	40	30	M5	M/60125/M
55	80	M8 x 16 deep	M8 x 10 deep	33	6,8	12	15	12,5	30	10	7	27,5	50	26,5	50	36	M6	M/60132/M
68,5	100	M10 x 18 deep	M10 x 12 deep	36	8,5	15	20	14,5	36	11	9	32,5	60	31,5	60	40	M8	M/60140/M

BC	BD	BE	Ø BF	BG	BH	BJ	BK	Ø BL	BN	BP	BT	BU	BX	BZ	EE	EE1	Model
8 H7	3	16	3,2	40	59	27,5	8	10	20	54	25	36	64	66	M 5	M 5	M/60116/M
8 H7	3	30	5,3	59	82	35	10	16	22	76	35	48	90	92	M 5	M 5	M/60125/M
12 +0.12	5	36	6,4	82	104	43	11	20	28	102	46	62	116	118	G 1/8	M 5	M/60132/M
12 +0.12	5	40	8,4	104	128	54,5	15	25	31	126	57	74,5	144	146	G 1/8	G 1/8	M/60140/M

Model	Strokes (mm)	25	50	75	100	125	150	175	200	225
		M/60116/M	BR	113,5	113,5	163,5	163,5	213,5	213,5	-
	BS	179	204	279	304	379	404	-	-	-
M/60125/M	BR	-	152	152	202	202	252	252	-	-
	BS	-	246	271	346	371	446	471	-	-
M/60132/M	BR	-	-	190	190	240	240	290	290	-
	BS	-	-	321	346	421	446	521	546	-
M/60140/M	BR	-	-	-	236,5	236,5	286,5	286,5	336,5	336,5
	BS	-	-	-	398	423	498	523	598	623

**Intermediate stroke length screw**

Slide unit	Control range (mm)				
	5	10	15	20	25
M/60116/M	M/P70870/1	M/P70870/2	M/P70870/3	M/P70870/4	M/P70870/5
M/60125/M	M/P70870/1	M/P70870/2	M/P70870/3	M/P70870/4	M/P70870/5
M/60132/M	M/P70870/6	M/P70870/7	M/P70870/8	M/P70870/9	M/P70870/10
M/60140/M	M/P70870/6	M/P70870/7	M/P70870/8	M/P70870/9	M/P70870/10

**Service kit**



Slide unit	Service kit
M/60111/M	QM/60111/M/00
M/60116/M	QM/60116/M/00
M/60125/M	QM/60125/M/00
M/60132/M	QM/60132/M/00
M/60140/M	QM/60140/M/00

Technical data - Reed switches - additional informations see data sheet N/en 4.3.005

Symbol	Voltage		Current maximum (mA)	Function	Operating temperature (°C)	LED	Protection class	Plug	Cable length (m)	Cable type	Weight (g)	Model
	(V a.c.)	(V d.c.)										
	10 ... 240	10 ... 170	180	Closer	-25 ... +80	•	IP66	—	2, 5 or 10	PVC 2 x 0,25	37	M/50/LSU/V
	10 ... 240	10 ... 170	180	Closer	-25 ... +80	•	IP66	—	5	PUR 2 x 0,25	37	M/50/LSU/5U
	10 ... 240	10 ... 170	180	Closer	-25 ... +150	—	IP66	—	2	Silicon 2 x 0,25	37	TM/50/RAU/2S
	10 ... 240	10 ... 170	180	Changeover	-25 ... +80	—	IP66	—	5	PVC 3 x 0,25	37	M/50/RAC/5V
	10 ... 60	10 ... 60	180	Closer	-25 ... +80	•	IP66	M8 x 1	0,3	PVC 3 x 0,25	16	M/50/LSU/CP *1)

\* Insert cable length; \*1) Plug-in connector see page 11; Color code: BK = black, BN = brown, BU = blue

Drawings

M/50/LSU/V, M/50/LSU/5U,  
TM/50/RAU/2S  
Cable length L = 2, 5 or 10 m

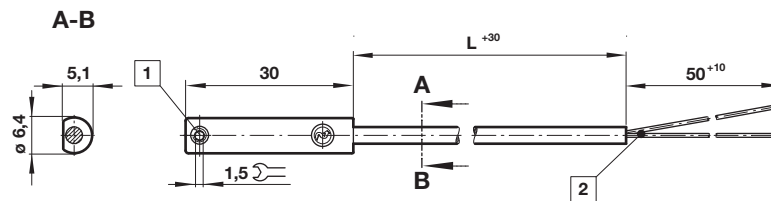

M/50/RAC/5V  
Cable length L = 5 m

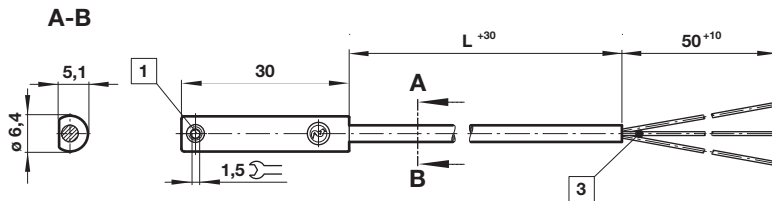

M/50/LSU/CP

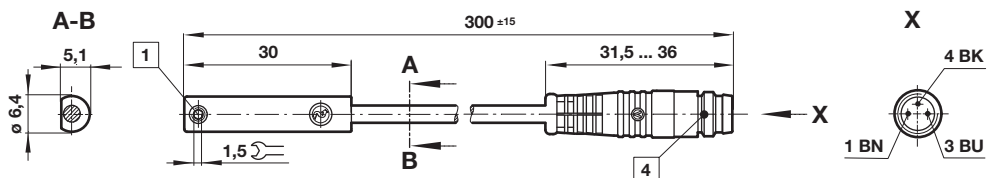

- 1 Fixing screw
- 2 + BN = brown; - BU = blue (output)
- 3 - BK = black; + BN = brown; - ≠BU = blue
- 4 Plug M8 x 1, color code: BK = black; BN = brown; BU = blue

Dimensions in mm  
Projection/First angle



Accessories

Switch mounting bracket



MP72487

Plug-in connector cable with nut



Outer cover	Cable length (m)	Weight (kg)	Connector	Connector
PVC 3 x 0,25	5 m	0,18	M8 x 1	M/P73001/5
PUR 3 x 0,25	5 m	0,18	M8 x 1	M/P73002/5
PUR 3 x 0,34	5 m	0,21	M12 x 1	M/P34594/5

**Technical data - Solid state - additional informations see data sheet N/en 4.3.007**

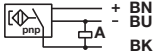
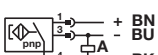
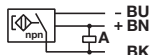
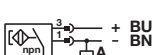
Symbol	Voltage (V d.c.)	Current maximum (mA)	Function	Operating temperature (°C)	LED	Protection class	Plug	Cable length (m)	Cable type	Weight (g)	Model
	10 ... 30	150	PNP	-40 ... +80	•	IP67	—	2, 5 or 10	PVC 3 x 0,12	37	M/50/EAP/*V
	10 ... 30	150	PNP	-40 ... +80	•	IP68	—	5	PUR 3 x 0,14	37	M/50/EAP/5U
	10 ... 30	150	NPN	-40 ... +80	•	IP67	—	2, 5 or 10	PVC 3 x 0,12	37	M/50/EAN/*V
	10 ... 30	150	Closer	-40 ... +80	•	IP67	M8 x 1	0,3	PVC 3 x 0,14	16	M/50/EAN/CP *1)

\* Insert cable length; \*1) Plug-in connector below; Color code: BK = black; BN = brown; BU = blue

**Drawings**

M/50/EAP/\*V,  
M/50/EAN/\*V  
Cable length L = 2, 5 or 10 m

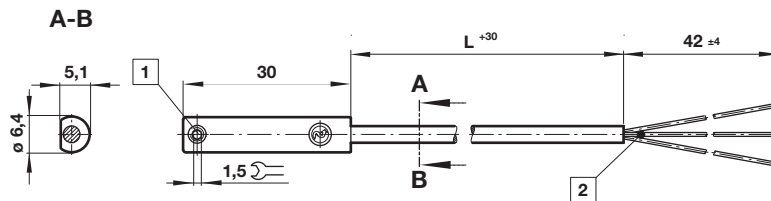

Dimensions in mm  
Projection/First angle



M/50/EAP/CP,  
M/50/EAN/CP

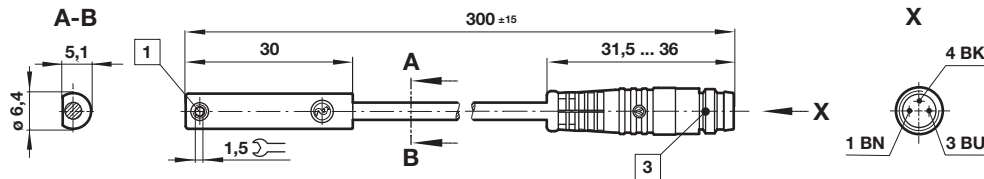

M/50/EAP/CC

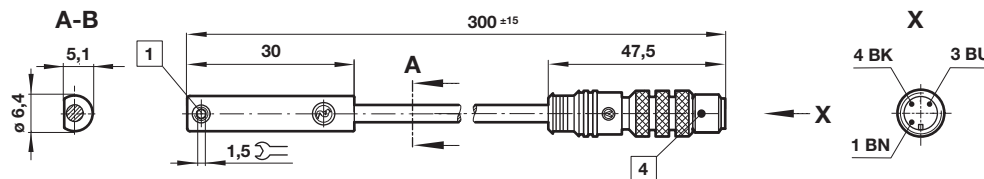

- 1 Fixing screw
- 2 Color code: BK = black; BN = brown; BU = blue
- 3 Plug M8 x 1
- 4 Plug M12 x 1

**Warning**

These products are intended for use in industrial compressed air systems only. Do not use these products where pressures and temperatures can exceed those listed under

»Technical features/data«.

Before using these products with fluids other than those specified, for non-industrial applications, life-support systems or other applications not within published specifications, consult IMI NORGREN.

Through misuse, age, or malfunction, components used in fluid power systems can fail in various modes.

The system designer is warned to consider the failure modes of all component parts used in fluid power systems and to provide adequate safeguards to prevent personal injury or damage to equipment in the event of such failure.

System designers must provide a warning to end users in the system instructional manual if protection against a failure mode cannot be adequately provided.

System designers and end users are cautioned to review specific warnings found in instruction sheets packed and shipped with these products.